

SECTION A-A

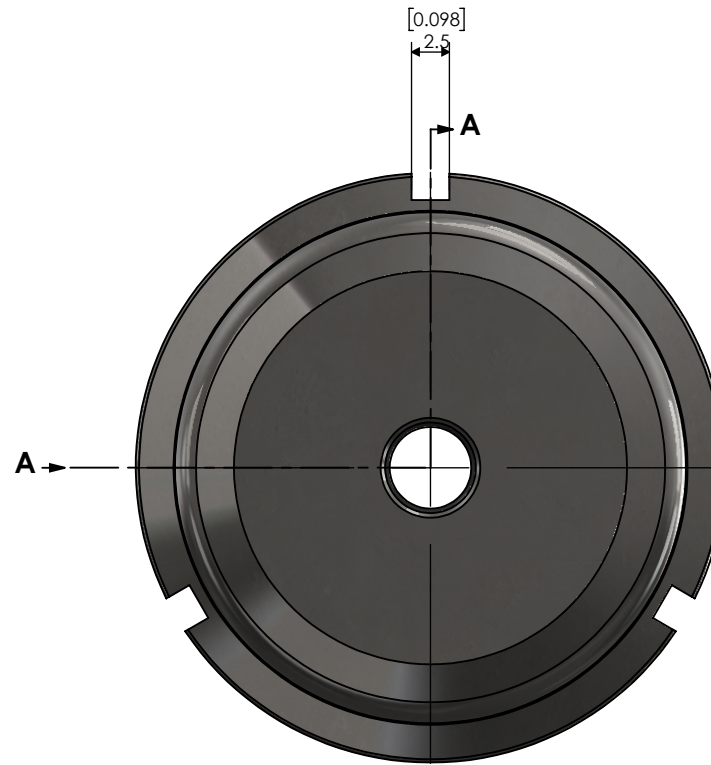

PROPRIETARY AND CONFIDENTIAL

THE INFORMATION CONTAINED IN THIS DRAWING IS THE SOLE PROPERTY OF LYNDEX NIKKEN. ANY REPRODUCTION IN PART OR AS A WHOLE WITHOUT THE WRITTEN PERMISSION OF LYNDEX NIKKEN IS PROHIBITED. DRAWING SUBJECT TO CHANGE WITHOUT NOTICE.

NOTES:

CCK Coolant Seal Nut/Cap OD25mm(1") ID6mm



SIZE A	DWG. NO. CKFN25(1)-6C	REV. 1
SCALE 2:1		SHEET 1 OF 1