

SECTION A-A

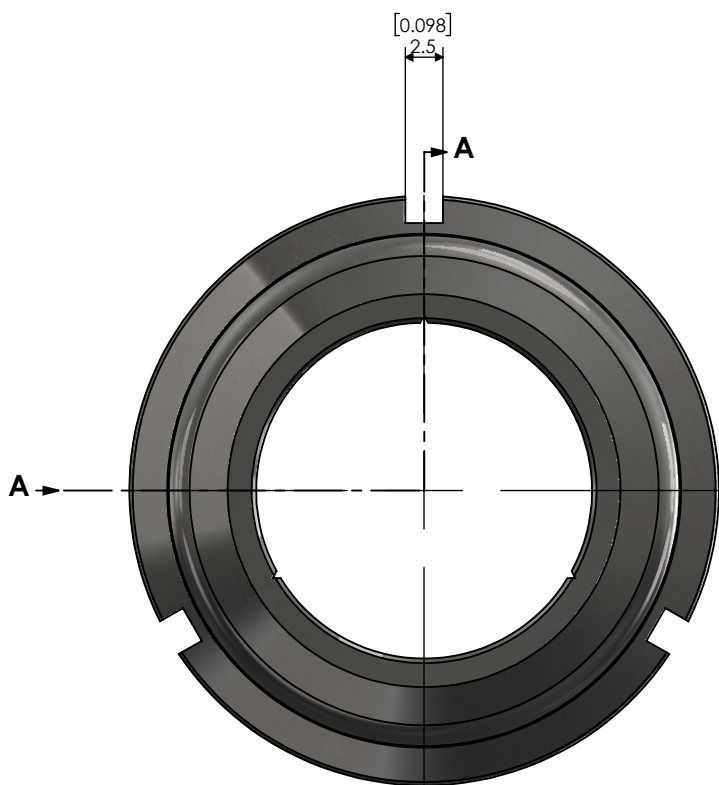

<p>PROPRIETARY AND CONFIDENTIAL</p> <p>THE INFORMATION CONTAINED IN THIS DRAWING IS THE SOLE PROPERTY OF LYNDEX NIKKEN. ANY REPRODUCTION IN PART OR AS A WHOLE WITHOUT THE WRITTEN PERMISSION OF LYNDEX NIKKEN IS PROHIBITED. DRAWING SUBJECT TO CHANGE WITHOUT NOTICE.</p>	NOTES:	CCK Coolant Jet Slot Nut/Cap OD25mm(1") ID7/8"
	<p>SIZE A</p> <p>SCALE 2:1</p>	<p>DWG. NO. CKFN25(1)-7/8</p> <p>REV. 1</p> <p>SHEET 1 OF 1</p>