

SCALE 2:1

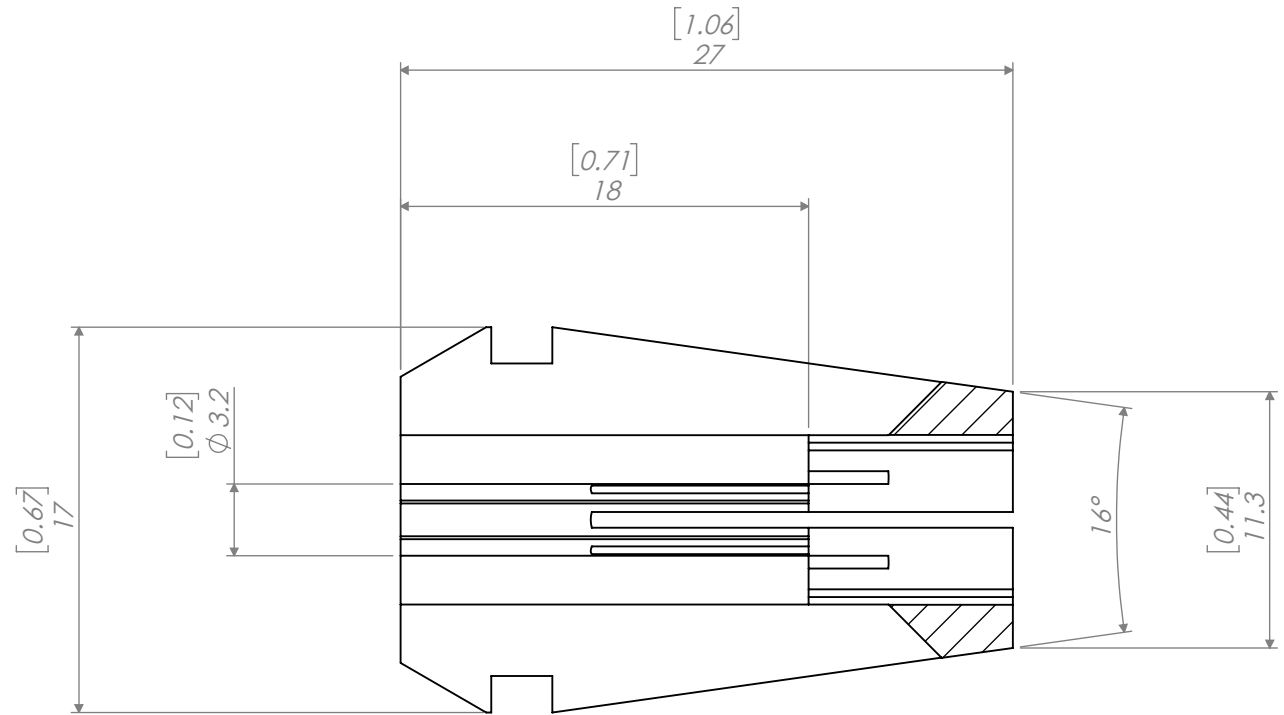

REVISIONS			
REV.	DESCRIPTION	DATE	APPROVED

NOTES:

UNLESS OTHERWISE SPECIFIED:

DIMENSIONS ARE IN MM [INCH]

DIMENSIONS ARE FOR REFERENCE ONLY. DRAWING IS SUBJECT TO CHANGE WITHOUT FURTHER NOTICE.

INTERPRET GEOMETRIC TOLERANCING PER: ASME Y 14.5M

THIRD ANGLE PROJECTION

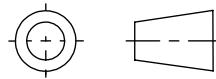

NAME

DATE

DRAWN AM 09/21/20

CHECKED

ENG APPR.

MFG APPR.

Q.A.

PROPRIETARY AND CONFIDENTIAL

THE INFORMATION CONTAINED IN THIS DRAWING IS THE SOLE PROPERTY OF LYNDEX NIKKEN. ANY REPRODUCTION IN PART OR AS A WHOLE WITHOUT THE WRITTEN PERMISSION OF LYNDEX NIKKEN IS PROHIBITED.

ER16 COLLET 1/8"



SIZE
A

DWG. NO.
E16-008

REV

SCALE: 3:1

SHEET 1 OF 1