

SCALE 2:1

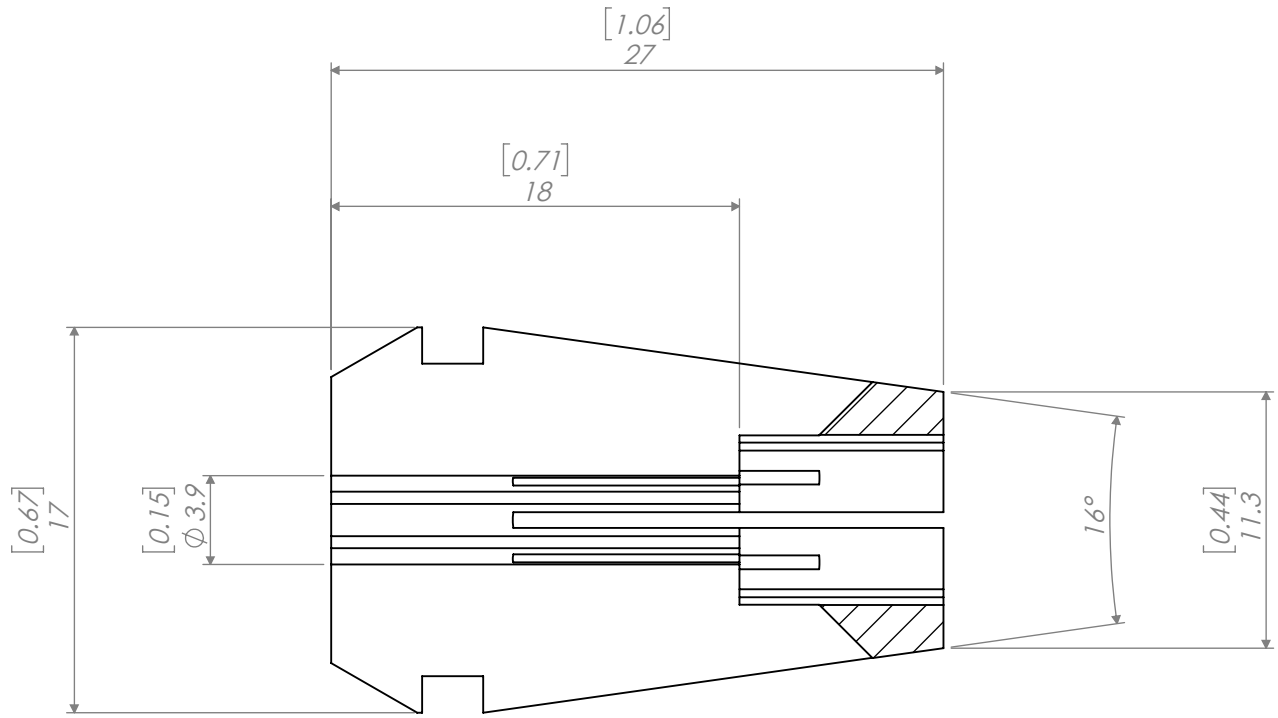

REVISIONS			
REV.	DESCRIPTION	DATE	APPROVED

NOTES:

UNLESS OTHERWISE SPECIFIED:

DIMENSIONS ARE IN MM
[INCH]

DIMENSIONS ARE FOR
REFERENCE ONLY. DRAWING
IS SUBJECT TO CHANGE
WITHOUT FURTHER NOTICE.

INTERPRET GEOMETRIC
TOLERANCING PER: ASME Y 14.5M

THIRD ANGLE PROJECTION

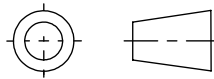

NAME

DATE

DRAWN AM 09/21/20

CHECKED

ENG APPR.

MFG APPR.

Q.A.

PROPRIETARY AND CONFIDENTIAL

THE INFORMATION CONTAINED IN THIS
DRAWING IS THE SOLE PROPERTY OF
LYNDEX NIKKEN. ANY REPRODUCTION
IN PART OR AS A WHOLE WITHOUT THE
WRITTEN PERMISSION OF LYNDEX NIKKEN
IS PROHIBITED.

ER16 COLLET 5/32"



SIZE
A

DWG. NO.
E16-010

REV

SCALE: 3:1

SHEET 1 OF 1